

User Manual

Before operating this equipment, read the instructions for usage and connection.

Ruby2



08548600

QUALITY ESPRESSO ©
Quality Espresso

Manufacturer of coffee machines since 1952

Ver.27-09/2012



WARNING

RISK OF FIRE OR ELECTRIC SHOCK
DO NOT OPEN



WARNING. TO REDUCE THE RISK OF FIRE OR ELECTRIC SHOCK.

DO NOT REMOVE COVER (OR BACK)



NO USER-SERVICEABLE PARTS INSIDE

REPAIR SHOULD BE DONE BY AUTHORIZED SERVICE PERSONNEL ONLY

1. Safety indications	2
1.1 Symbols	2
1.2 Safety indications	2-3
2. Descripción general Ruby 2	4
2.1 General Overview.	4
2.2 Product Selection Buttons	4
3. Instalación and Start-up	5
3.1 Prior to Installation	5
3.2 Instalación	5-6
3.3 Dose Programming.	7
4. Cleaning and Daily Care	7
4.1 External Cleaning.	7
4.2 Cleaning of Parts	7
4.3 Daily Care.	7
5. Selecting Pushbutton LED Illumination Mode	8
5.1 Illumination Modes	8
5.2 Procedure for Changing Illumination mode.	8
6. Warning Signals	8
7. Incidents and Possible Causes	9
8. Guarantee conditions	9
9. Contact Information	9

1. Safety Indications

1.1 Symbols

	WARNING May cause injuries.
	INFORMATION Important or useful information.
	RISK OF FIRE OR ELECTRIC SHOCK May cause injuries.

We ask you to carefully read this instruction manual before operating your new coffee machine for the first time. Keep these instructions in a safe place where you can consult them when necessary. The inappropriate use of this machine exempts Quality Espresso from any liability.

1.2 Safety indications

Installation	<ul style="list-style-type: none">The machine should only be installed by authorized technical personnel. The manufacturer declines any liability for possible injuries caused by inappropriate installation.																								
Transport	<ul style="list-style-type: none">The use of gloves and a minimum of two people is recommended to manually move the machine to its installation site.																								
Storage	<ul style="list-style-type: none">The machine should be stored in areas with a temperature higher than 5° C.In the event of storage or transport of the machine in temperatures lower than 0° C, and in order to prevent freezing, the machine's hydraulic circuit should be emptied first.In the event of freezing, the machine should be placed in an area with a temperature higher than 10° C to wait for unfreezing. Under no circumstances should the machine be connected to the electrical circuit before it is unfrozen.																								
Placement	<ul style="list-style-type: none">It is recommended that the machine be installed in a spacious area, free of air currents and with a solid base. Avoid installing the machine on a wet or hot surface.Regulate the height of the machine with the support legs. Maximum inclination cannot be greater than 1° between any of its axes.																								
Electrical Connection 	<ul style="list-style-type: none">Check that all of the electrical connection characteristics comply with the voltage, frequency and wattage indications described on the machine's specification plate. This plate is located on the chassis under the drainage tray. <div data-bbox="481 1552 901 1702"><table border="1"><tr><td colspan="2">QUALITY ESPRESSO, S.A.</td><td>CE</td></tr><tr><td colspan="2">n. registro APF-28/44289-B</td><td>directivo 97/23/CE</td></tr><tr><td colspan="2">Tipo: QUALITY</td><td>Made in Spain</td></tr><tr><td>marca: QUALITY</td><td>ref.: QUALITY VISION EC SILICE</td><td>0510096310</td></tr><tr><td>modelo: AQV006</td><td>n. serie: 0110096</td><td>semanario fab.: 23/03/19</td></tr><tr><td>tensión: 400 V 3N ~ /230V 3 ~ /230V ~ 50/60Hz</td><td>potencia: 4400W</td><td></td></tr><tr><td>p. diseño: 0.18 Mpa</td><td>vol.: 5 l.</td><td>presión agua alimentación: máx. 0.5 Mpa - mín. 0.2 bar</td></tr><tr><td>registro instalador: <input type="text"/></td><td>fecha instalación: <input type="text"/></td><td>pinzon instalador: <input type="text"/></td></tr></table></div> <ul style="list-style-type: none">We consider the machine to be installed correctly when it has been connected to a magneto-thermic omnipolar circuit breaker appropriate to the machine's power, along with a differential that does not exceed a residual current of 30 mA.The machine must be installed in accordance with the current electrical regulations of your area. You must make ensure that the electrical installation is reliably grounded in accordance with the aforementioned regulations. The company declines any liability for possible injuries caused by a defective installation or incorrect ground connection.Extension cords or outlet adapters of any kind should not be used to connect the machine to the power supply. The connection cable should never be rolled up, but instead it should be fully extended to avoid possible overheating.	QUALITY ESPRESSO, S.A.		CE	n. registro APF-28/44289-B		directivo 97/23/CE	Tipo: QUALITY		Made in Spain	marca: QUALITY	ref.: QUALITY VISION EC SILICE	0510096310	modelo: AQV006	n. serie: 0110096	semanario fab.: 23/03/19	tensión: 400 V 3N ~ /230V 3 ~ /230V ~ 50/60Hz	potencia: 4400W		p. diseño: 0.18 Mpa	vol.: 5 l.	presión agua alimentación: máx. 0.5 Mpa - mín. 0.2 bar	registro instalador: <input type="text"/>	fecha instalación: <input type="text"/>	pinzon instalador: <input type="text"/>
QUALITY ESPRESSO, S.A.		CE																							
n. registro APF-28/44289-B		directivo 97/23/CE																							
Tipo: QUALITY		Made in Spain																							
marca: QUALITY	ref.: QUALITY VISION EC SILICE	0510096310																							
modelo: AQV006	n. serie: 0110096	semanario fab.: 23/03/19																							
tensión: 400 V 3N ~ /230V 3 ~ /230V ~ 50/60Hz	potencia: 4400W																								
p. diseño: 0.18 Mpa	vol.: 5 l.	presión agua alimentación: máx. 0.5 Mpa - mín. 0.2 bar																							
registro instalador: <input type="text"/>	fecha instalación: <input type="text"/>	pinzon instalador: <input type="text"/>																							

Manipulation



- Any internal manipulation of the machine, except that which is specifically described in this manual regarding cleaning processes, must be performed by an authorized service technician.
- Cleaning and preventive maintenance according to the frequency indicated for the machine or service technician is required. The manufacturer declines any responsibility for possible damage to the machine due to non-compliance with these requirements, as well as damage due to the incorrect or inappropriate use of the machine.
- All machine components, including the connection cable, should only be replaced by original parts supplied by the authorized service technician or the manufacturer.
- Before proceeding with any maintenance operations, disconnect the machine from the electrical supply either through the mains general switch or by disconnecting the power cable.



Consejos importantes

- Install the machine on a solid base.



- The machine should be used exclusively by adults. Children do not recognize the dangers associated with machines, hence it should be kept out of their reach or they should be prevented from using it. People with physical or sensory disabilities or decreased mental capacity, or people without experience should not use this machine without the supervision of staff qualified for that purpose.

- Do not use this machine outdoors unless it is protected from the external elements (wind, rain, fog, etc.)



- The equipment should not be exposed to running water or steam.

- Do not touch the machine with wet, moist or bare feet, or with moist or wet hands.

- The machine cannot be used for products other than those described in this manual.



- Avoid possible burns by not touching the outlets before, during or after serving a product. Be careful with the containers used to serve the products (cups, jars, glasses, etc.) because they may be hot.



- Do not pour water or insert wet containers into the upper part of the machine. The water may filter through the ventilation orifices and cause damage to the machine or the people using it.

2. General Description of Ruby 2

2.1 General Overview

Water Supply: Main Water Net
 Water Pump: Pump Rot. 8-9 bar.
 Element Wattage: 2.500 W (230 V)
 1.500 W (115 V)
 Boiler Capacity: 6,5 L.

A = 367 mm
 B = 567 mm
 C = 511 mm

1 - Hot Water knob	5 - Power Switch	9 - Drain Tray
2 - Product Selection Buttons	6 - Steam Arm	10 - Boiler Pressure Gauge
3 - Steam Knob	7 - Feet	11 - Filter Holder
4 - Cup Warmer Tray	8 - Drip tray	12 - Hot water Outlet

2.2 Product Selection Buttons

<p>a - On Coffee b - Continuous Coffee c - Two Coffees</p>	<p>d - Boiler Water Level indicator f - Heating Element Indicator</p>
--	--

3. Installation and Start-up

3.1 Prior Installation

Verify before Installing:

1. Drainage tube with an interior diameter no less than 35 mm.
2. Mains water network supply tube connected to water softener.
3. Stopcock with 3/8" G exit.
4. Grounded plug protected with a magneto-thermic circuit breaker.
5. Water supply tube (supplied with machine) from water softener.
6. Drain tube
7. Water softener

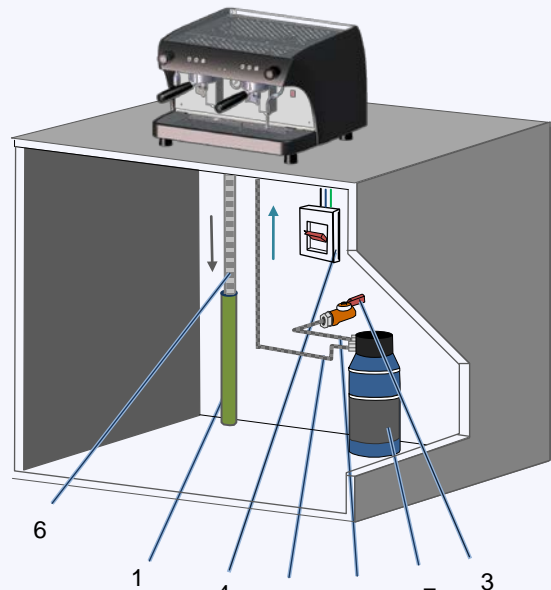

3.2 Installation

Once the machine has been unpacked, the following steps should be performed:

Check that the electricity supply voltage is the same as that listed on the specification plate and in the machine's documentation.

QUALITY ESPRESSO, S.A.		CE
s. registro: APT/04/04/2010		
Tipo: MOCINO		
marca: QUALITY		Marka: Quality
modelo: A2000	ref.: QUALITY VISION 2C SLICE	
n. serie: 01010001	identificación: 01010001	
tensión: 400 V 3φ ~ 230 V 3 ~ 50/60Hz	potencia: 4400W	001000010
p. diseño: 0.18Mpa	rel.: 0.1	presión agua alimentación: máx. 0.5Mpa mín. 0.2 bar
registro instalador:	duración:	
fecha instalación:	instalador:	

1. Place the machine on the workbench and connect the water supply from the stopcock (1), to the softener (2).
 - Let the water flow to clean it.

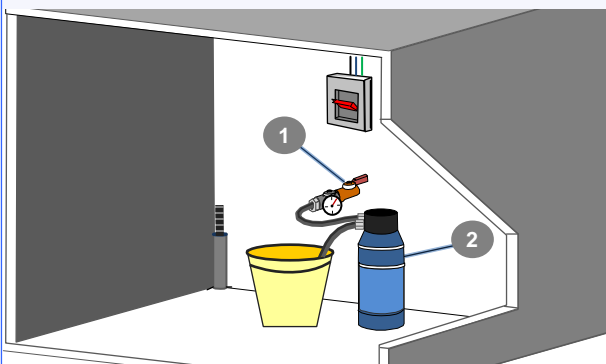

It is recommended to use water with a hardness between 5-8 dH° (8-14 fH°), to avoid calcification and to obtain an optimal quality of coffee and tea.

2. Connect the water supply tube from the outlet softener to the water inlet of the machine (3).
 - Open the stopcock (1) and check that the connection is not leaking.



- Open the steam tap.



3 Connect the drainage tube to the machine



Lead the drainage tube through the opening at the base of the machine and connect the tube to the fitting. Then, lead the end of the tube to the drain.

i It is important that the drainage tube is completely straight with no angles in order to facilitate good drainage.

4 Connect the machine plug to the appropriate connection base according to the current electrical standards of the area.



i You should not use extension cords or outlet adapters of any kind to connect the machine to electricity network.

The network connection cable, should never be rolled up; instead, it should be fully extended to avoid possible overheating.

5 Press the main power switch.
At start-up the electronic control box detects that there is no water in the boiler and activates the filling valve and the pump. These remain active until the level probe detects adequate water level. As soon as this occurs, the boiler element will switch on, heating the entire system.



i If the control box does not detect an adequate water level in the boiler within 6 minutes, the one-coffee and two-coffee LED keys plus the level indicator LED will blink, indicating a water level warning. This warning can be cancelled by turning the machine off and on again.

6 Place the filter holder in the group head, press the continuous coffee button to purge the group, let water flow for 30 seconds. Then wait approximately 15 minutes until the machine is at normal working temperature, observing whether the gauge indicates a pressure of 1 bar.

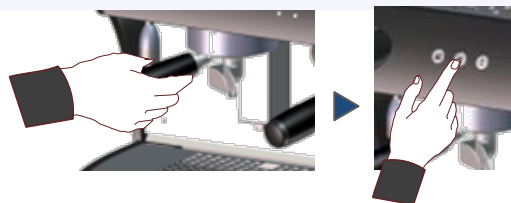

7 While the machine is heating, proceed with the installation of the grinder. Adjust the grinding point and doses.

8 Once the machine has reached working temperature and we have adjusted the grinder, we can program the coffee doses (see section 3.3, pg. 7)

3.3 Dose Programming

- We can program the amount of coffee one the one-coffee and two-coffee pushbuttons.

1 Enter Program mode:	
<ul style="list-style-type: none"> • With the machine turned off, hold down the continuous coffee button. Turn on the machine and wait 4 seconds with the continuous coffee key pressed until the selection button lights turn off. Only the one-coffee and two coffee buttons are programmable. 	
2 Programming the Amount	<p>Flowmeter alarm</p> <p><i>If we are programming the amount of coffee for one coffee and two coffees and more than 15 seconds go by without detecting counter impulses, the flowmeter warning will be activate and the one-coffee and two-coffee keys will begin to blink. To turn off the blinking, press any key, which will return you to programming mode. If after trying again the warning signal appears, call a service technician.</i></p>
<ol style="list-style-type: none"> Put the ground coffee or the capsule (according to the model) in the filter holder for one or two coffees and insert into the group head. Press the one-coffee key of the left group for more than 3 seconds until the coffee begins to come out. When you have reached the desired amount of coffee, press the same key again. Repeat these steps on the two-coffee key. To exit programming mode you must turn off and turn on the machine again with the main power switch. Doses of the first group are copied to the second group. 	

4. Cleaning and Daily Care

- Keep the machine in optimal conditions of cleanliness is a daily requirement for guaranteeing the necessary hygiene and good Quality of the final beverage, as well as a longer service life for the machine.

4.1 External Cleaning	4.2 Group Head Rinsing
<p>Do not use any chemical or abrasive products to clean the machine. Only use a cotton cloth moistened with water. Pay special attention to the pushbuttons and the areas related to beverage preparation: the steam arm, the hot water outlet and the filter holder and group head.</p>	<p>Rinse the group head daily to maintain an optimal quality of coffee. To clean the coffee holder, follow these instructions.</p> <ol style="list-style-type: none"> Put the blind filter in the filter holder. Insert the filter holder into the part. Press the continuous coffee key and wait 10 seconds. Press the continuous key again to stop and wait 10 seconds. <p>Repeat this cleaning cycle 15 times, until the water comes out clean thorough the discharge valve.</p>

4.3 Daily care

At the beginning of the day	At the end of the day
<ol style="list-style-type: none"> Activate the group head for 20 seconds to urge the water in the circuit. Check that the water comes out through the shower in a single, continuous stream. If it does not, clean it with the blind filter. Replace the part and spout if the problem persists. Remove from the grinder dispense chamber any ground coffee from the previous day. Verify that the ground coffee dose and grinding point are correct. Prepare a coffee and verify that it comes out correctly. 	<ol style="list-style-type: none"> Limit the amount of coffee to be ground to single servings since the ground coffee from one day should be discarded the next. Rinse the group head with the help of the blind filte. Clean the filter and the filter holder with hot water and hold it up to the light to make sure the filter holes are not obstructed. Leave the filter holder in the group head without over-tightening it. Clean the steam arm with a damp cloth and purge it several times. Clean the drainage tray.

Practical Advice

- Do not stack cups more than three cups high.
- Avoid reheating milk. Heat in small amounts.
- Before foaming milk, open the steam valve to purge it. Once the foaming is done, purge again and clean the tube with a damp cloth.

5. Selecting Pushbutton LED Illumination Mode

5.1 Illumination modes

We can choose between 3 different illumination modes for the product selection pushbuttons.

a. LED MODE 1

By default, all the pushbuttons are unlit. When we press a button that key lights up and the others remain unlit.

b. LED MODE 2

By default, all the pushbuttons are illuminated. When a button is pressed, it remains illuminated and the others turn off.

c. LED MODE 3

By default, all the pushbuttons are illuminated. When a pushbutton is pressed, it will turn off and the others will remain illuminated.



5.2 Procedure for changing the illumination mode

With the machine turned off, simultaneously press the one-coffee and continuous coffee keys of the group 1 (left). Without releasing the buttons, press the mains power switch and wait for all three lights to begin blinking, indicating that you have entered into the illumination selection mode.

- Press the one-coffee pushbutton to select "Mode 1".
- Press the continuous coffee pushbutton to select "Mode 2".
- Press the two-coffee pushbutton to select "Mode 3".

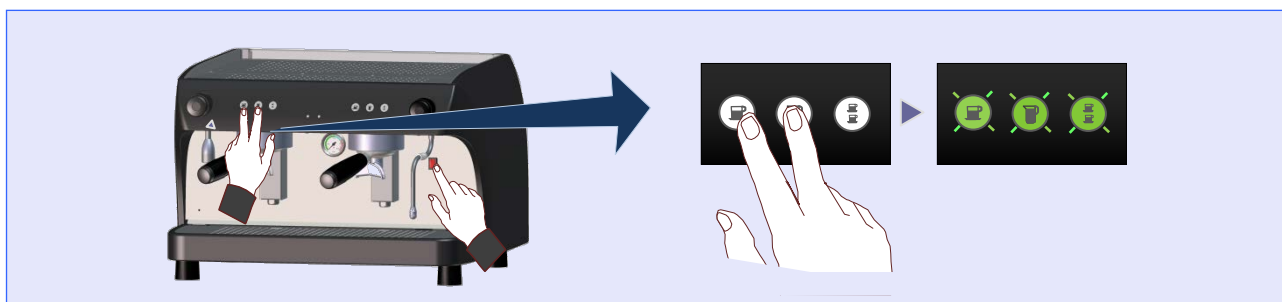

6. Alarm and Indication Signals

Alarms

Flowmeter Alarm

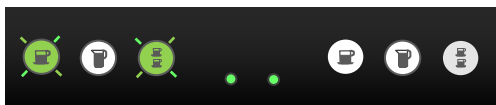

Boiler water level Alarm



Indications



Boiler Refilling Indicator



Boiler Heating Element On



7. Incidents and Possible causes

SYMPTOMS	POSSIBLE CAUSES	COMMENTS
<ul style="list-style-type: none"> Noisy Pump 	<ul style="list-style-type: none"> Blocked pump. No water in the network. Obstruction in water supply. 	<ul style="list-style-type: none"> If the water has particles suspended in it or is too hard, you should install a water softener filter.
<ul style="list-style-type: none"> Slow dispensing, burnt coffee. 	<ul style="list-style-type: none"> Incorrect calibration of the pump. 	<ul style="list-style-type: none"> Check the pump pressure with a gauge.
<ul style="list-style-type: none"> Slow dispensing. Burnt and cold coffee. Dark cream, with a tendency to be porous. One coffee and two coffee lights blinking, on any of both touch-buttons. 	<ul style="list-style-type: none"> Grinding point too fine. Low pump pressure. Injector filter dirty, partially obstructed. Flowmeter does not work correctly. Coffee is excessively fine or there is no water. 	<ul style="list-style-type: none"> If they are blinking and to know whether it is due to the coffee, or due to a lack of water or due to the flowmeter, take out the filter holder and press the Button, if the blinking continues and water has come out, it may be due to the flowmeter.
<ul style="list-style-type: none"> One coffee, two coffee keys and LED level indicator blinking. 	<ul style="list-style-type: none"> Boiler water level alarm has been activated. 	<ul style="list-style-type: none"> Check that the main water valve is open. The warning will disappear once the machine is turned off and turned on again.

8. Guarantee conditions

All components of the machine are guaranteed for 12 months (from installation) against any defect that affects correct operation. The **GUARANTEE** exclusively covers replacement of parts with manufacturing defects. Under no circumstances does it imply complete replacement of the machine.

This guarantee does not cover glass, rubber or plastic components or electrical parts that cause damage or affect the operation of other components, due to fluctuations in the main voltage supply nor parts that are worn out by normal use.

Any machines that may have been manipulated by unauthorized personnel or those with indications of incorrect use, will forfeit all conditions of this **GUARANTEE**.

Only authorized **TECHNICAL SERVICES**, are able to offer guaranteed repairs using **ORIGINAL** parts. Any labour, travel and lodging costs for the repair of any product are at the user's expense.

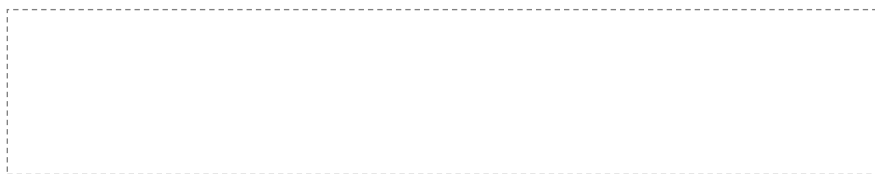

9. Información de contacto

Dirección de contacto

QualityEspresso S.A.

Fabricantes de máquinas de café espresso desde 1952

Motores, 1-9

08040 Barcelona

Tel. +93 223 12 00

Fax +93 223 20 17

Export Tel. +34 933 946 305

Export Fax +34 933 322 111

www.qualityespresso.net

e-mail: info@qualityespresso.net